

XAG DL1 Data Link User Manual

Version 1.0 **EN**

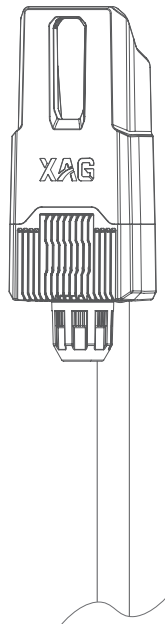

To User

Dear user, thank you for choosing XAG's product.

For safety purposes and better user experience, it is highly recommended that you read this manual carefully and strictly follow the instructions hereof.

Contact Us

Manufacturer: Guangzhou Xaircraft Technology Co., Ltd.

Add: XSpace, No.115, Gaopu Road, Guangzhou, Guangdong Province, China

Technical Support Team: support@xa.com

Introduction

XAG DL1 Data Link (hereinafter referred to as "Data Link") provides long-range Wi-Fi link for XAG's smart agricultural devices, which improves the signal strength of the dedicated Wi-Fi link and extends its communication range. It serves as a link repeater between the remote controller and the drone, so that the remote controller can reach further, making it possible to operate in the vehicle, or in the case of high crops or fruit trees.

List of Items

Please see that all of the following items are present when unpacking the box. Should there be any item missing, please contact your seller.

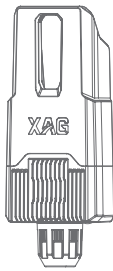

Core Device
X 1

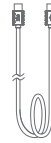

Type-C Cable
X 1



Hose Clamp
X 2

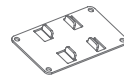

Mounting Plate
X 1



M4 Screw
x 4

Main Components

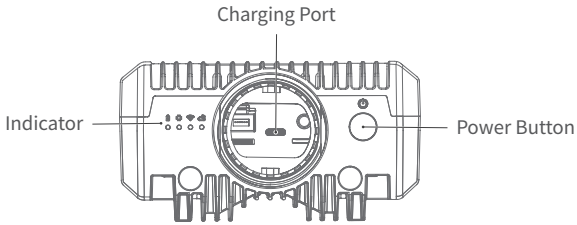
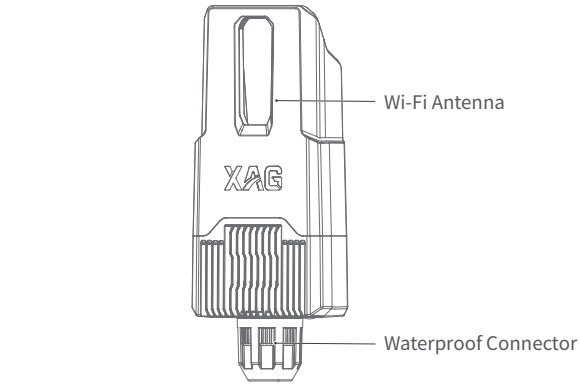























Bottom View

Power Button

Action	Description
Short Press	Battery Level
Long Press	Power On/Off

Indicator

The indicators will show you the current status of the Data Link. The definitions are as follows.

Indicator	Status		Description
Power 	Solid red		Battery level 1% - 20%
	Solid Yellow		Battery level 21% - 50%
	Solid Green		Battery level 51% - 100%
	Blinking Red		Charging. Battery level 1% - 20%
	Blinking Yellow		Charging. Battery level 21% - 50%
	Blinking Green		Charging. Battery level 51% - 99%
System 	Solid Red		System failure
	Solid Green		System is normal
	Blinking Yellow		System is booting
	Blinking Green		Bluetooth connected
LAN 	Solid Red		Wi-Fi failure
	Solid Green		Wi-Fi is normal
	Blinking Yellow		Wi-Fi configuration in progress
	Blinking Green		Device connected
Ethernet 	Solid Red		Ethernet failure. Connection failure.
	Solid Green		Ethernet connected
	Blinking Yellow		Ethernet connection in progress
All ^[1]	Blinking Red		Firmware update in progress

[1]: "All" refers to all indicators, i.e. Power indicator, System indicator, LAN indicator, and Ethernet indicator.

How to Use

Charging

- ① Remove the waterproof connector assembly by turning it counterclockwise, and separate the waterproof connector, waterproof silicone, and waterproof collet.
- ② Pass the Type-C cable through the holes of the connector, silicone, and collet, and plug it into the charging port of the Data Link; Plug the other end into the charging adapter^[1], and then connect it to the power source. The Power indicator will turn solid green when the device is fully charged.

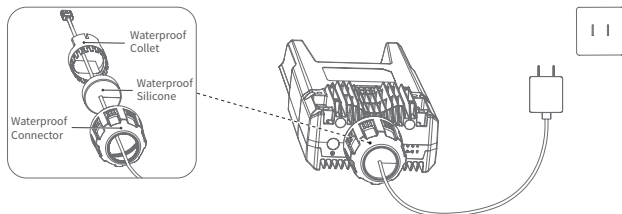

[1]: The charging adapter, which is not included in the list of items, needs to be purchased separately.

Install Hose Clamp

- ① Create a hose clamp assembly by passing the hose clamps through the two holes in the mounting plate.



- ② Align the hose clamp assembly with the screw holes on the back of the Data Link and secure with four M4 screws.

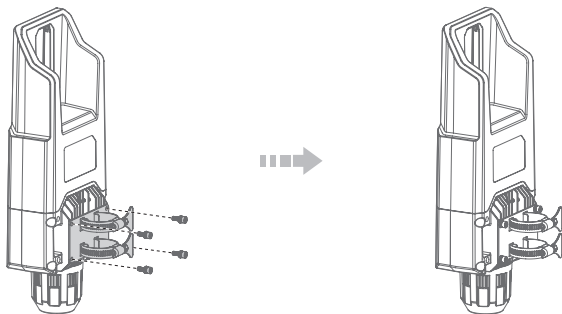

Download XAG One App





Android: Scan the QR code above to download/install XAG One.

iOS: Search for "XAG One" in the App Store to download and install the app.

Add a Device

Before using the Data Link for the first time, it is necessary to follow the steps below to add it to XAG One on your mobile phone or the SRC4 Smart Remote Controller (hereinafter referred to as the "remote controller").



1. Open XAG One, register and log in with your mobile phone number.
2. Go the "Feild  " screen on your phone or the main screen on the remote controller, tap the icon  , select "Add a Device  ", tap "...", and select "Add via Bluetooth".
3. After scanning the device, select the one with the same serial number as yours, and tap "Add".
4. When it jumps to "Device Info Settings", tap "Next" to add the device.
5. When it shows "Added Successfully", you have completed adding the device.

Firmware Update

It is necessary to check for updates to the current firmware before use. Please make sure to install the latest version if it is not up to date.

1. Open XAG One and tap "Me" - "Device". Select your device and go to device details. Tap "Firmware Update" to check for new version.
2. If an update is available, tap "Download and Install". Wait for the update to complete, then tap "Finish". Go back to the device list and check if the firmware is up to date. If not, repeat the steps above until all updates are installed.

Note

-  Before adding a device, please make sure that "XAG One" App and its firmware version have been updated to the latest version.
-  Before adding a device, please make sure that there are no obstacles blocking the Data Link, you have enabled location services on your phone or remote controller, and the "XAG One" App has location and Bluetooth permissions.
-  When adding a device, please keep the phone or remote controller close to the device and enable Bluetooth to scan for nearby devices.

Device Pairing

After adding the Data Link, it is necessary to pair it with the operating device in the device list. Here are the steps for pairing.

1. Open "XAG One" App, tap on "Device" on "Me" screen, and select the Data Link that needs to be paired.
2. Tap on "Device Pairing", place the phone or remote controller close to the device that needs to be paired and scan it.
3. After successfully scanning the device, select the current device and select "OK" in the pop-up window.
4. When "Paired Successfully" appears on the screen, it means the pairing is complete.

Data Link Installation

- ① Install the Data Link vertically on the top of the post.
- ② Tighten the handle on the clamps to fix the Data Link.

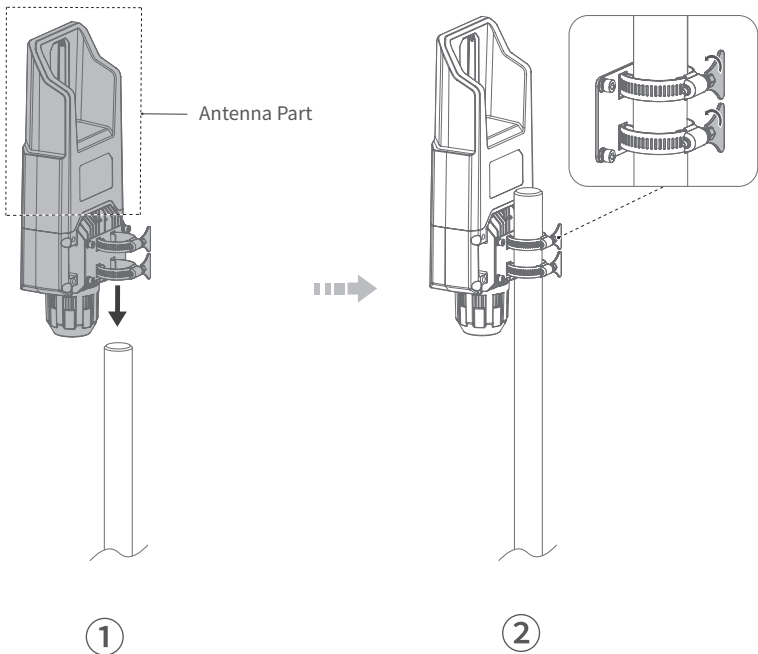

Note

- ⚠ Users need to purchase the post that match the Data Link. It is recommended to choose circular or square post with a diameter or edge length of 30-50 mm. The post model in the manual is for reference only; the installation should be based on the actual object.
- ⚠ The installation height of the post can be adjusted according to the actual operation scenario. In unobstructed operation areas, it is suggested to install at a height of around 1.5 meters; in areas with high crops, fruit trees, or other obstructions, please make sure that the installation height is higher than the obstructions.
- ⚠ Please make sure that the post is securely installed and kept vertically upright. The clamps connecting the Data Link and the post must be tightened to make sure that the device will not shake.
- ⚠ Ensure that the antenna part of the Data Link is always upward, and the Data Link is vertical to the ground. The antenna should not be close to metal, so as not to affect the communication.
- ⚠ To ensure communication distance, the post should not obstruct the antenna part.

Precautions

- Before transporting the Data Link, it must be securely placed. If necessary, use shock-absorbing materials to wrap it tightly to prevent collisions or accidents during transportation.
- When the Data Link is idle, please shut down and disconnect the power, and store it horizontally in a safe, cool place away from heat sources.
- Please pay attention to the safety protection during installation to avoid personal injury or safety accidents caused by falling device.
- Before use, please make sure that the firmware version and the "XAG One" App have been updated to the latest version.
- Please pay attention to the remaining battery level when using the device to avoid low battery causing shutdown and affecting the operation.
- For long-term storage, it is recommended to charge the device every 6 months and keep the battery level between 30% and 50% to ensure battery activity.
- Instances where users do not follow the manual for usage, storage, transportation, maintenance, or where product faults or damage occur due to human error, are not covered under the product warranty.

Specifications

Model	M3DL1A
Dimensions	331×132×75 mm
Weight	1.6 kg
Wi-Fi Operating Frequency	SRRC: 2.4000 ~ 2.4760 GHz, 5.7250 ~ 5.8290 GHz FCC/CE: 2.4000 ~ 2.4835 GHz, 5.7250 ~ 5.8500 GHz MIC: 2.4000 ~ 2.4835 GHz
Wi-Fi Effective Isotropic Radiated Power (EIRP)	2.4 GHz: <33 dBm (FCC) <20 dBm (SRRC/CE/MIC) 5.8 GHz: <33 dBm (FCC) <30 dBm (SRRC) <14 dBm (CE)
Power Consumption	7.5 W
Power Connector	USB Type-C
Charging Input	5.0V 3.0 A/12.0V 1.5 A/15V 2 A, PD3.0 Protocol
Battery Type	Li-ion
Battery Capacity	14,700 mAh
Protection Rating	IP65
Ambient Temperature for Operating	-20 °C ~ 50 °C / -4 °F ~ 122 °F
Ambient Temperature for Storage	-20 °C ~ 25 °C / -4 °F ~ 77 °F (3 months < storage time < 1 year) -20 °C ~ 45 °C / -4 °F ~ 113 °F (1 month < storage time < 3 months) -20 °C ~ 45 °C / -4 °F ~ 131 °F (within 1 month)
Max. Communication Distance (no interference/obstruction)	SRRC: 2,000 m FCC: 2,000 m CE/MIC: 1,000 m
Compatibility	XAG P150 2024 Agricultural Drone XAG P60 2024 Agricultural Drone XAG Smart Remote Controller 4

Compliance Information

FCC Compliance Notice

Note: This equipment has been tested and found to comply with the limits for a Class A digital device, pursuant to part 15 of the FCC Rules. These limits are designed to provide reasonable protection against harmful interference when the equipment is operated in a commercial environment. This equipment generates, uses, and can radiate radio frequency energy and, if not installed and used in accordance with the instruction manual, may cause harmful interference to radio communications. Operation of this equipment in a residential area is likely to cause harmful interference in which case the user will be required to correct the interference at his own expense.

This equipment complies with FCC and Canada radiation exposure limits set forth for an uncontrolled environment. This equipment should be installed and operated with a minimum distance of 20cm between the radiator and your body.

This transmitter must not be co-located or operating in conjunction with any other antenna or transmitter.

Any changes or modifications not expressly approved by the party responsible for compliance could void the user's authority to operate the equipment.

Brand name / model number: M3DL1A

This device complies with part 15 of the FCC Rules. Operation is subject to the following two conditions: (1) This device may not cause harmful interference, and (2) this device must accept any interference received, including interference that may cause undesired operation.

Suppliers Name(FCC): Pegasus Spray Inc

Suppliers Address (FCC): 2235 79th Ave NE, Medina, WA 98039, USA

Suppliers phone number and / or internet contact information: +1 (503) 866-1228

EU Compliance Statement

Guangzhou Xaircraft Technology CO.,LTD.All Rights Reserved.hereby declares that this device is in compliance with the essential requirements and other relevant provisions of the RED Directive. This equipment must be installed and operated in accordance with provide instructions and the antenna used for this transmitter must be installed to provide a separation distance of at least 20cm from all persons and must not be co-located or operation in conjunction with any other antenna or transmitter. End-users and installers must be provide with antenna installation instructions and transmitter operating conditions for satisfying RF exposure compliance.

“Hereby, [Guangzhou Xaircraft Technology CO.,LTD.], declares that this [DL1 Data Link] is in compliance with the essential requirements and other relevant provisions of 2014/53/EU.

The full text of the EU declaration of conformity is available at the following internet address:
www.xa.com/en/service/downloads”

Suppliers Name(EU): NIK ELECTRONICS LTD

Suppliers Address (EU) : Sofia, 11B Brussels Blvd., fl.13

Suppliers phone number and / or internet contact information: 00359899952228

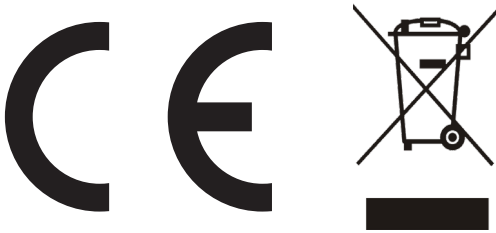

Warning: Operation of this equipment in a residential environment could cause radio interference.

KCC Warning Message

이 기기는 업무용 환경에서 사용할 목적으로 적합성 평가를 받은 기기로서 가정용 환경에서 사용하는 경우 전파 간섭의 우려가 있습니다 .

NCC statement

取得審驗證明之低功率射頻器材，非經核准，公司、商號或使用者均不得擅自變更頻率、加大功率或變更原設計之特性及功能。低功率射頻器材之使用不得影響飛航安全及干擾合法通信；經發現有干擾現象時，應立即停用，並改善至無干擾時方得繼續使用。前述合法通信，指依電信管理法規定作業之無線電通信。低功率射頻器材須忍受合法通信或工業、科學及醫療用電波輻射性電機設備之干擾。

Without permission granted by the NCC, any company, enterprise, or user is not allowed to change frequency, enhance transmitting power or alter original characteristic as well as performance to a approved low power radio-frequency devices. The low power radio-frequency devices shall not influence aircraft security and interfere legal communications; If found, the user shall cease operating immediately until no interference is achieved. The said legal communications means radio communications is operated in compliance with the Telecommunications Management Act. The low power radio-frequency devices must be susceptible with the interference from legal communications or ISM radio wave radiated devices.

減少電磁波影響，請妥適使用。

電波功率密度 MPE 標準值：0.9mW/cm²，送測產品實測值：0.088 mW/cm²，建議使用時設備天線至少距離人體 20 公分。

警告使用者：此為甲類資訊技術設備，於居住環境中使用時，可能會造成射頻騷動，在此種情況下，使用者會被要求採取某些適當的對策。

取得審驗證明之低功率射頻器材，非經核准，公司、商號或使用者均不得擅自變更頻率、加大功率或變更原設計之特性及功能。低功率射頻器材之使用不得影響飛航安全及干擾合法通信；經發現有干擾現象時，應立即停用，並改善至無干擾時方得繼續使用，前述合法通信，指依電信管理法規定作業之無線電通信。低功率射頻器材須忍受合法通信或工業、科學及醫療用電波輻射性電機設備之干擾。

Disclaimer

1. Please read the User Manual carefully before using this product. This Disclaimer has much to do with both operational safety and your legitimate rights and interests. You shall be deemed to have acknowledged, understood, agreed to, and accepted all the terms and conditions as well as information stated in the User Manual upon the use of this product.
2. Not a toy and with certain risks, this product is not suitable for those who are under 18 years old, those who have no or limited capacity for civil conduct, or those with mobility impairments. Please keep children away from this product and be particularly cautious when operating this product with children present.
3. Operator pledges to use the product within the bounds of the law for legitimate purposes only and agrees to the terms and conditions stated herein as well as potential related policies and norms formulated by XAG.
4. Please install, use, transport, and maintain the product under the instructions in this User Manual. Do NOT modify or disassemble this product on your own as any malfunction or damage arising therefrom or resulting from your improper use will not be covered by the warranty, and you shall solely assume the liability arising therefrom, both financially and legally.
5. You pledge to use the product within the bounds of the law for legitimate purposes only and agree to all the information stated in the User Manual.
6. To the maximum extent permitted by law, under no circumstances shall XAG offer any implicit or explicit guarantee for this product, including but not limited to implicit guarantees pertaining to vendibility, fitness for a particular use, or non-infringement.
7. To the maximum extent permitted by law, XAG shall not be liable for any losses caused by user's improper operation. In addition, XAG shall not be liable for any indirect, consequential, punitive, accidental, special, or exemplary damages, including any loss incurred as a result of your purchase, use, or inability to use the product (even if you have been advised of the possibility of such loss).
8. To the maximum extent permitted by law, under any circumstances, the liability or compensation amount from XAG to you for all damages, losses, and litigation arising therefrom will not exceed the amount that you paid to XAG or its authorized dealers for purchasing the product, except for the liability or amount to be borne by XAG otherwise stated in the legally binding final verdict or ruling by judiciary accounting for XAG's violation of laws and regulations or obligations.
9. You understand that in the use of any products, accidents may occur as a result of single or combined factors, including but not limited to improper operation, surroundings, and communication networks. You understand that the aforesaid accidents are reasonable and acceptable in the use of the product and that XAG shall not be held accountable for such accidents.
10. On any account, purchaser or user shall comply with the laws and regulations of the country and region where the product is used. XAG shall assume no liability arising from the violation of relevant laws and regulations by the purchaser or user.
11. Please note that the services provided by this product and its accessories might involve the collection, storage as well as processing of the geographic information and data of farmland. Before using this product, be sure to comply with local laws and regulations related to the collection, storage, and processing of such geographic information and data. Make sure that you use this product in accordance with the law. Any financial and legal liability arising from user's violations of the laws and regulations shall be borne solely by the user.

12. As exclusion clauses may be prohibited by law in some countries, your rights in different countries may vary. However, this does not imply that partial or all terms contained in this Disclaimer are necessarily invalid.
13. To the extent permitted by law, all interpretations and revisions of the terms and conditions stated hereinabove are at XAG's sole discretion, and XAG's decisions will be final. XAG also has the right to update, modify, or terminate these terms and conditions via its official website, User Manual, online App, etc., without prior notice.

Warning

User is required to read through the User Manual and be fully familiar with the operation of this product before operating it. Otherwise, improper operation of the product may cause injury to the user or others, or cause damage to the product and property loss. Safety awareness is of great importance during operation. Do NOT use the parts that are not provided or suggested by XAG. Please install and use the product in strict accordance with XAG's instructions.



overseas@xa.com



@XAGofficial



@xag_official



@XAG Official